



# Assembly Instruction

ITEM NO. 9928BLK/DBR-3

## DOUBLE RECLINING SOFA WITH DROP DOWN CUP-HOLDERS

NOTE: Do not use power tools for assembly. Power tools increase the risk of over tightening which lead to splitting or cracking the wood.

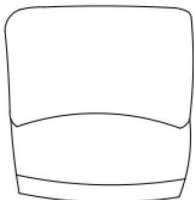
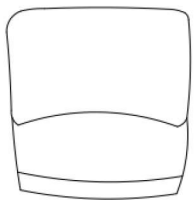
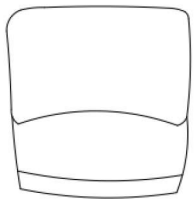
### PARTS LIST

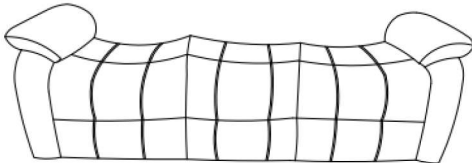
NO.	DRAWING	QTY	DESCRIPTION
A		1	LSF BACK REST
B		1	MIDDLE BACK REST
C		1	RSF BACK REST
D		1	LSF EAR
E		1	RSF EAR
F		1	SEAT

Please follow the drawings below to assemble the item.

Note: LSF ear and RSF ear are stored at the bottom of arm, please take out for assembly.

**Step 1.** The location of the ear.

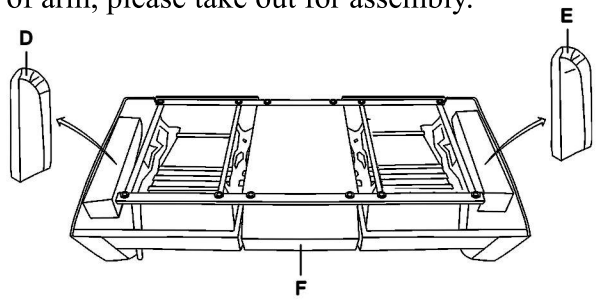

**Step 2.** Align the female brackets at the back rest onto the male brackets at the seat, insert and push to the end, make sure the brackets are secured in position.

**Step 3.** Insert the LSF ear and RSF ear to the back rest and make sure it is secured in position.

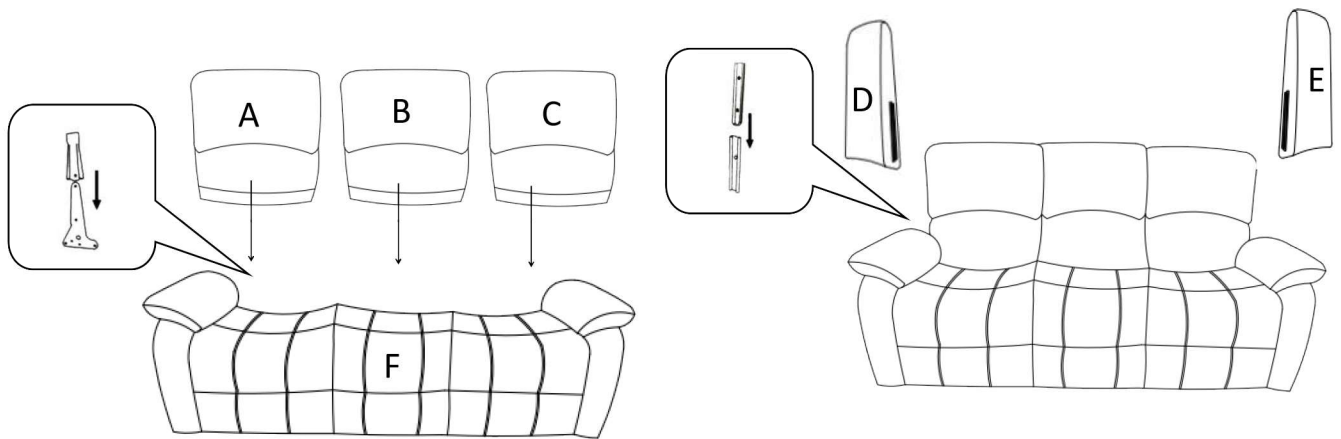

**Step 4.** Completed.

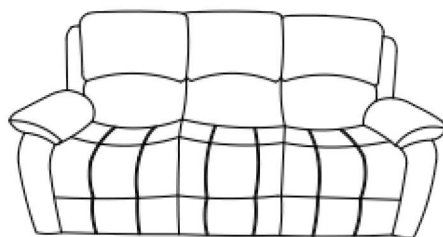

**Step 5.** Pull the middle back rest to the front to use cup holder.

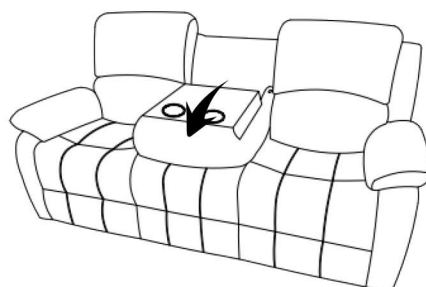

## CARE INSTRUCTION FOR PU FURNITURE

- Avoid exposing furniture directly to sunlight or heating and air conditioning outlets. Exposure to sunlight or heating and air conditioning outlets will fade/ Damage PU.

- Wipe gently with a damp soft cloth to remove dust, dirt and any grime buildup.



**For items use on wooden floor, hard surfaces or carpets, it is recommended to install protective pads under all legs and supports to avoid/prevent from damages/scratches and discoloration**