



Assembly Instruction









ITEM NO.: 9637SND-2 LOVE SEAT

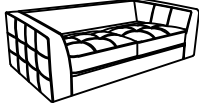

Back Rest is stored at the top of love seat, please take out it for assembly .

Note: Do not use power tools for assembly. Power tools increase the risk of over tightening which lead to splitting or cracking the wood.

Component list

No	Drawing	Qty	Description
A		1	SEAT
B		1	LSF BACK CUSHION
C		1	RSF BACK CUSHION
D		4	METAL LEG
E		8	BOLT (5/16" x 25mm)
F		8	SPRING WASHER (5/16")
G		8	FLAT WASHER (5/16"*19*1.5mm)
H		1	ALLEN KEY (M4*59mm)

Step #1

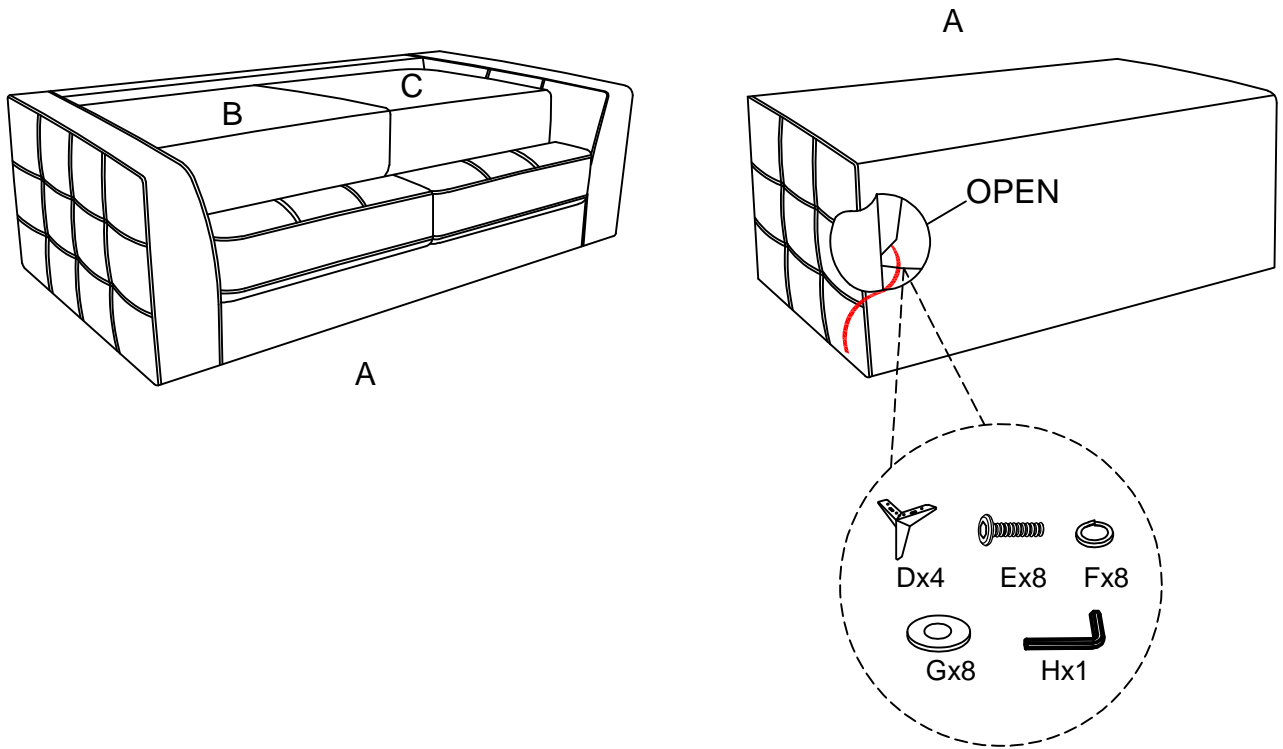

Step #2

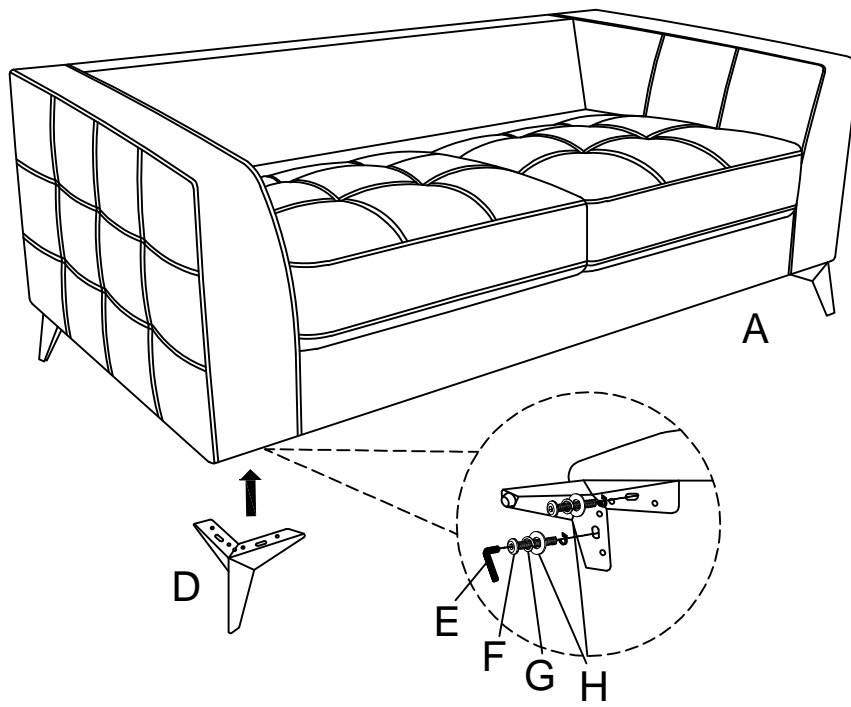

Step #3

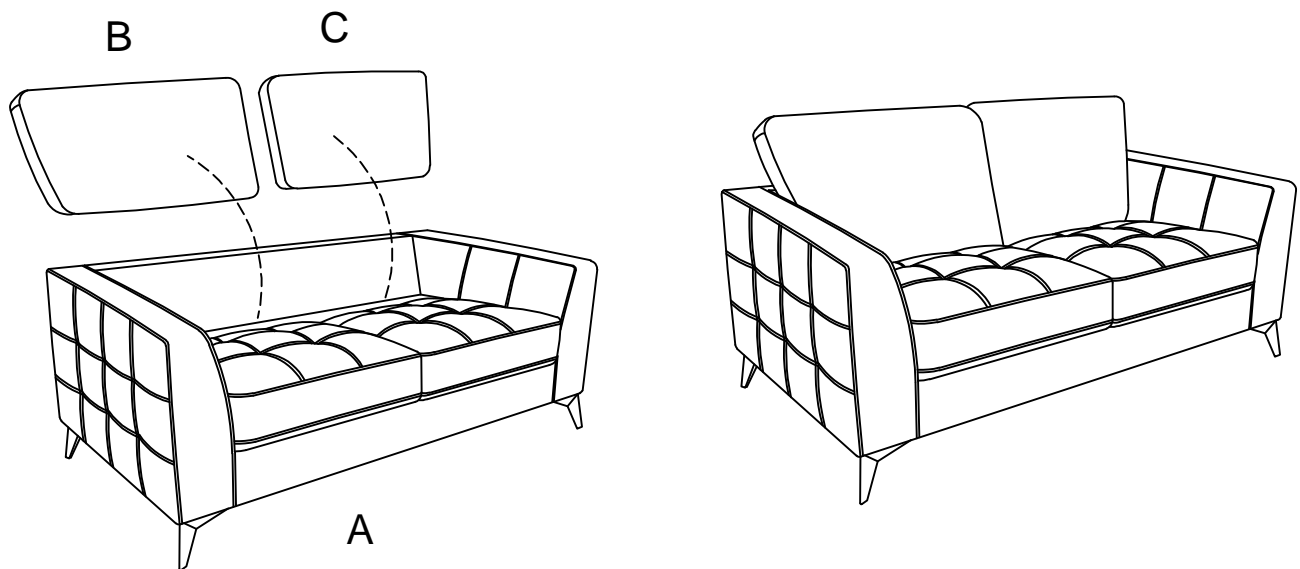

Care Instruction for Polished Microfiber Furniture:

In order to maintain the original appearance of your Polished Microfiber Furniture,

please follow below simple care procedures:

- Avoid exposing furniture directly to sunlight or heating and air conditioning outlets. Sunlight and or exposure to heating and air conditioning outlets will fade/damage Polished Microfiber.
- Vacuum or wipe with a soft cloth to remove dust.
- Hardware may loosen over time. Periodically check to make sure all connection are tight, Re-tighten if necessary.



For items use on wooden floor, hard surfaces or carpets, it is recommended to Install protective pads under all legs and supports to avoid/prevent from damages/scratches and discoloration.