

Assembly Instruction





ITEM NO.: 9555BEG/9555BRW-AC
(1/3) Armless Chair

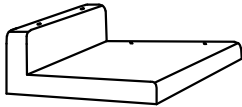

Legs & hardware are stored in the box, please take out the legs and hardware for assembly.

Note: Do not use power tools for assembly. Power tools increase the risk of over tightening which lead to splitting or cracking the wood.

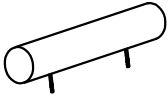
Chair Component list

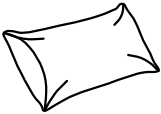
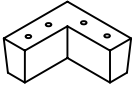
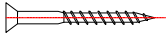
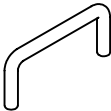
No	Drawing	Qty	Description
A		1	SEAT
B		1	SEAT CUSHION
C		1	HEADREST
D		1	BACK CUSHION
E		1	RECTANGULAR PILLOW 680*400*120mm
F		4	PLASTIC LEG 10*150*70mm
G		16	SCREW M4*70mm
H		2	CONNECTION LOCK 78*50*40mm

THE PARTS ARE LOCATED INSIDE THE BOX AS BELOW:

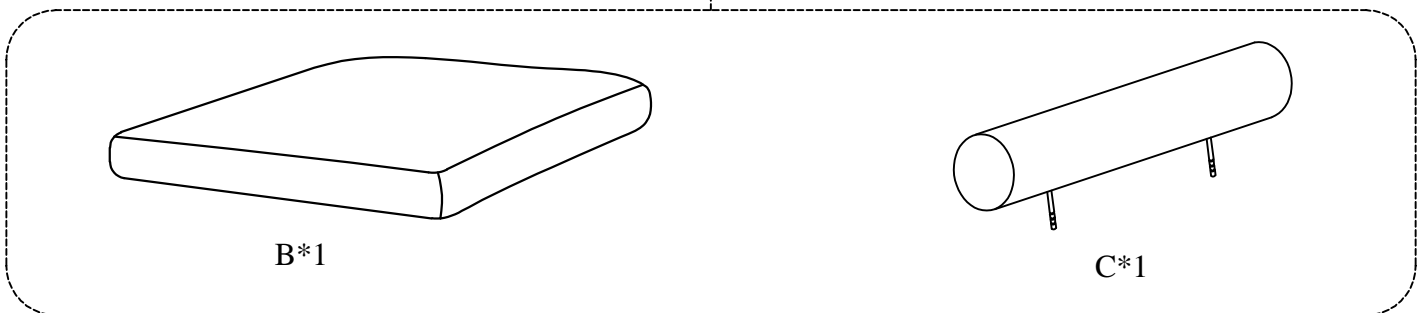
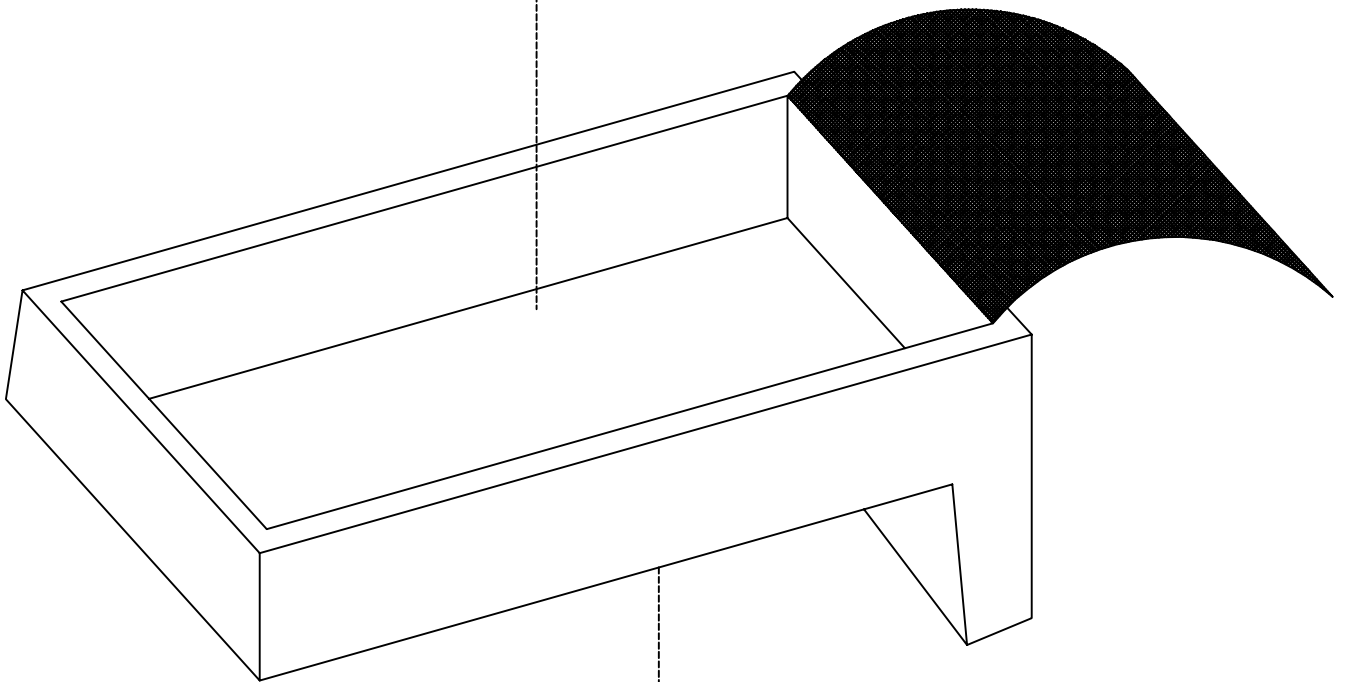
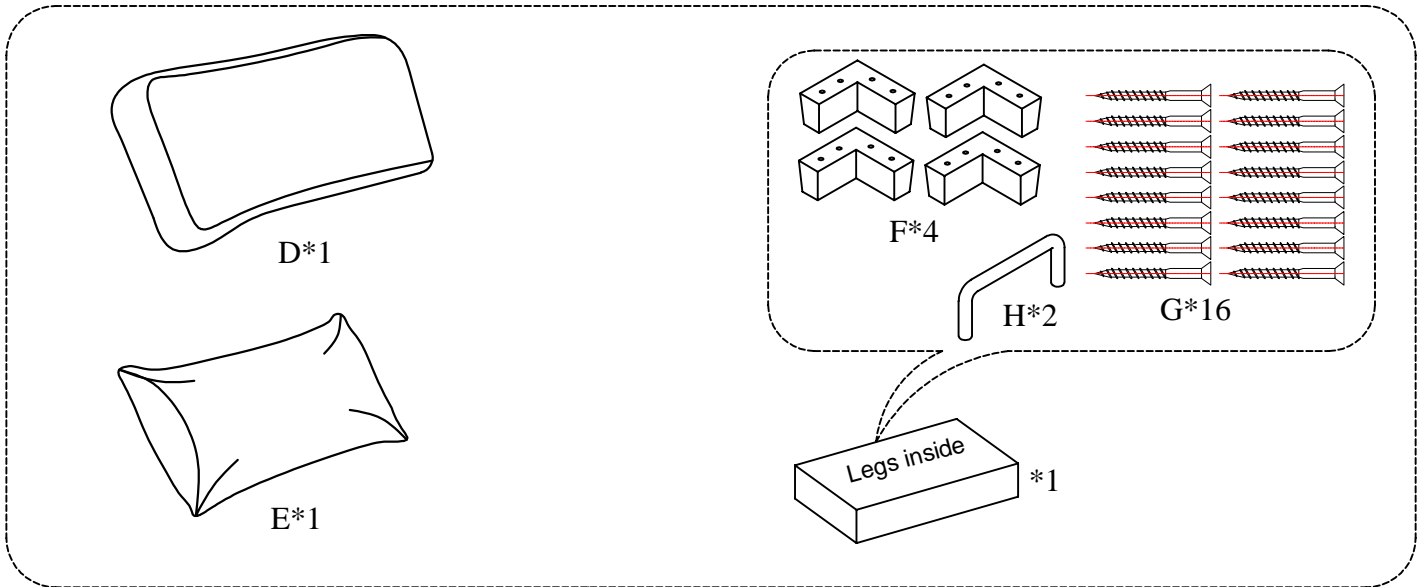

Step #1

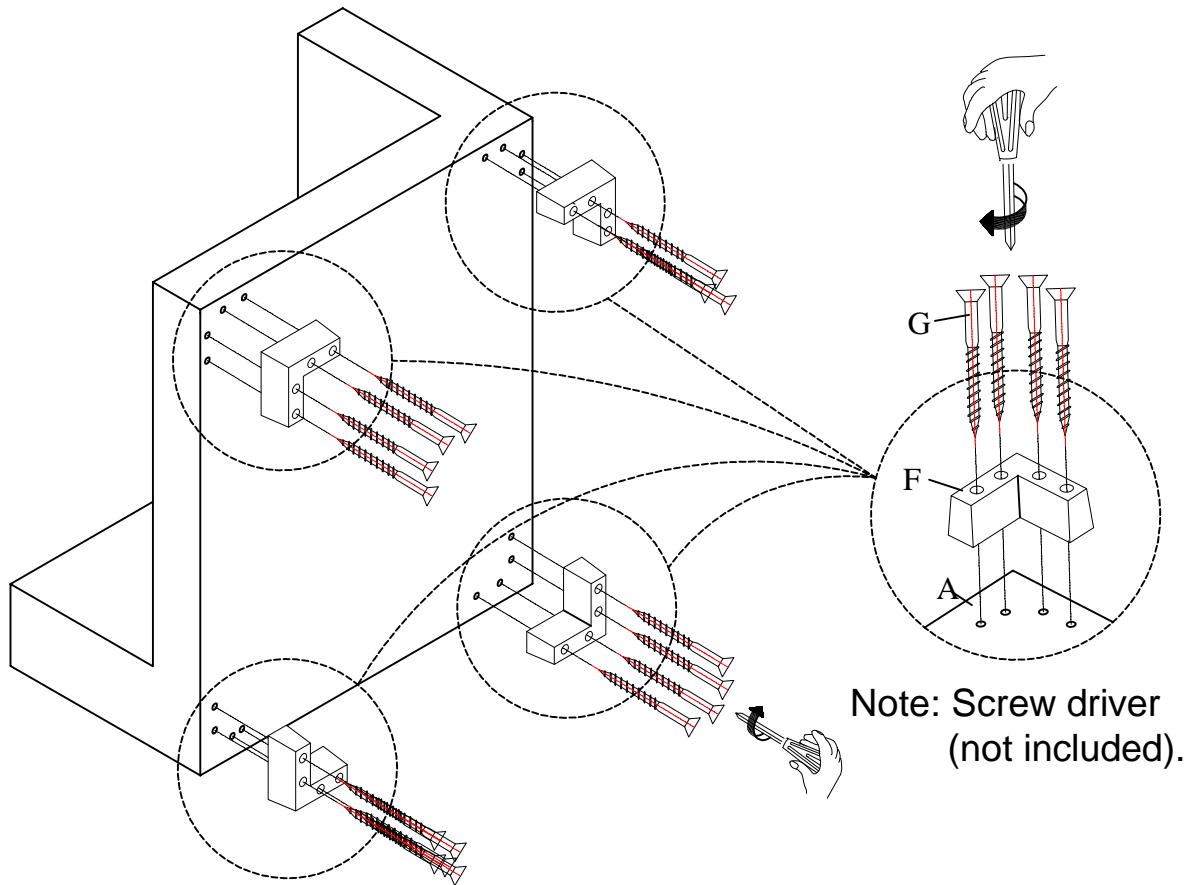

Step #2

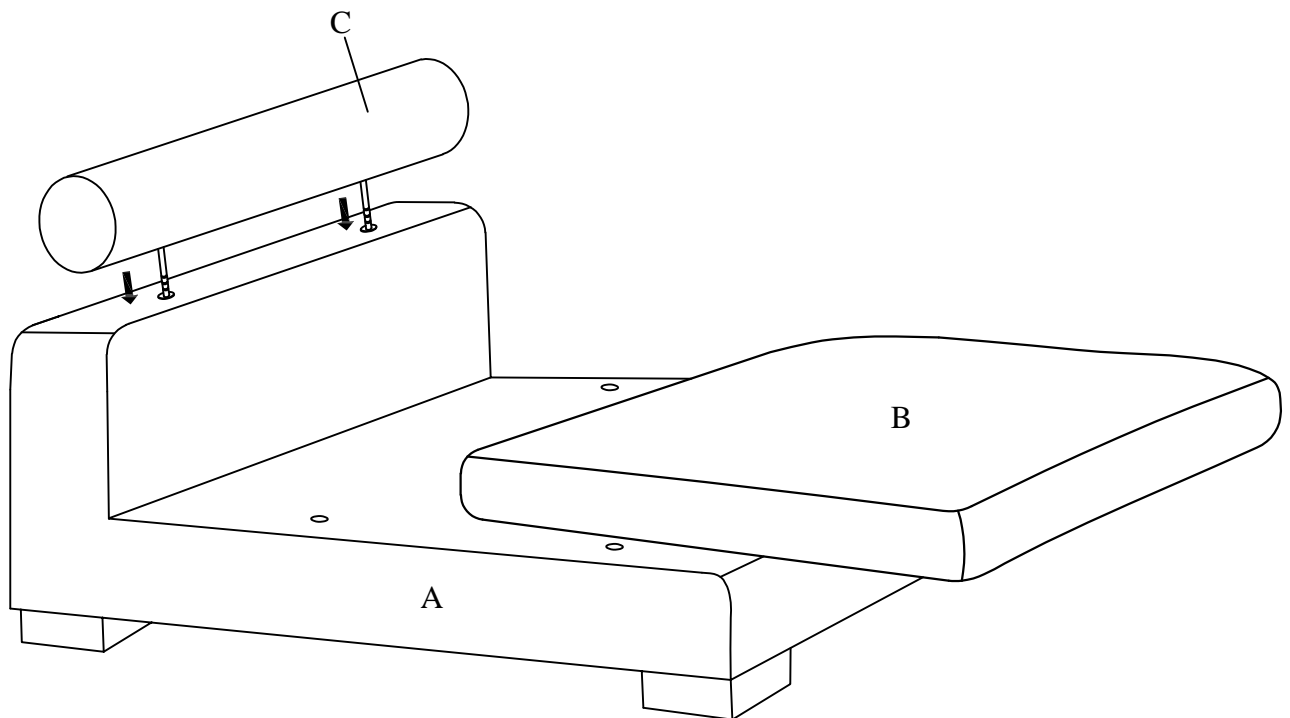

Step #3

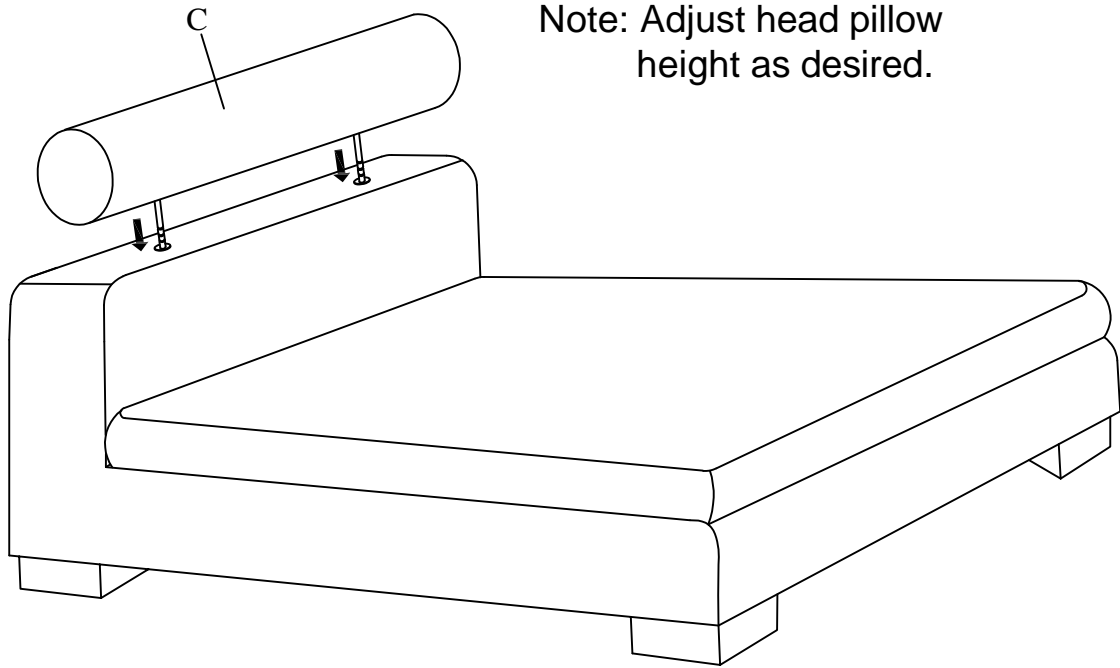

Note: Adjust head pillow height as desired.

Step #4

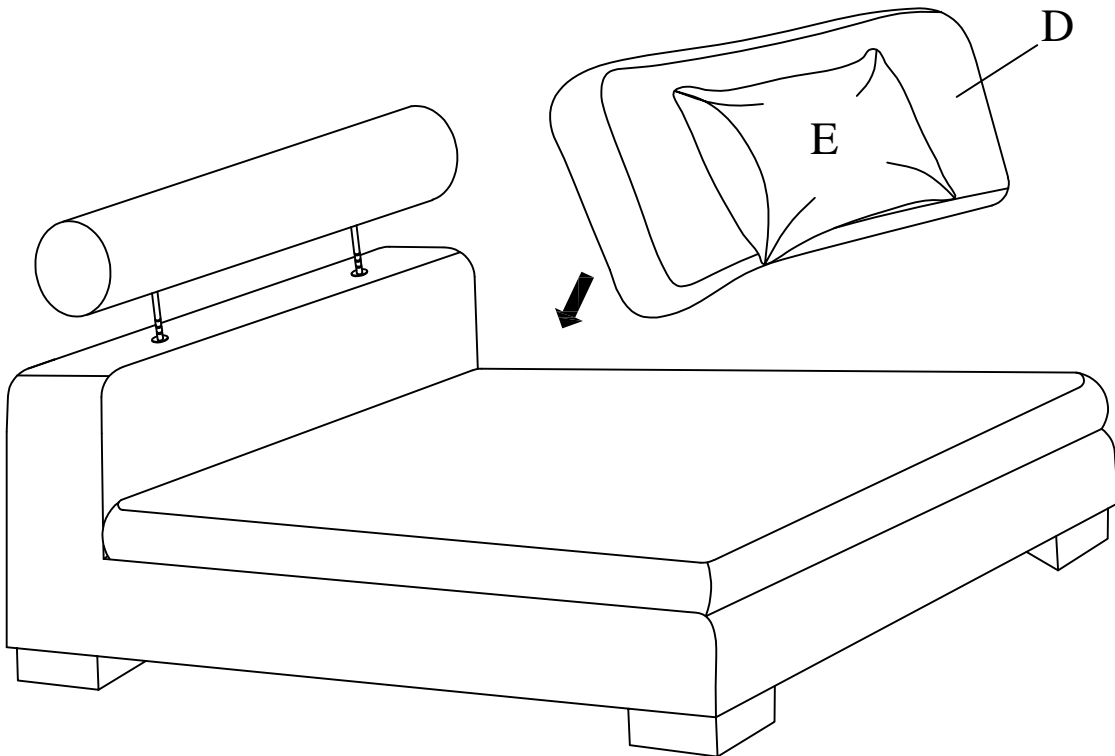

Step #5



Step #6

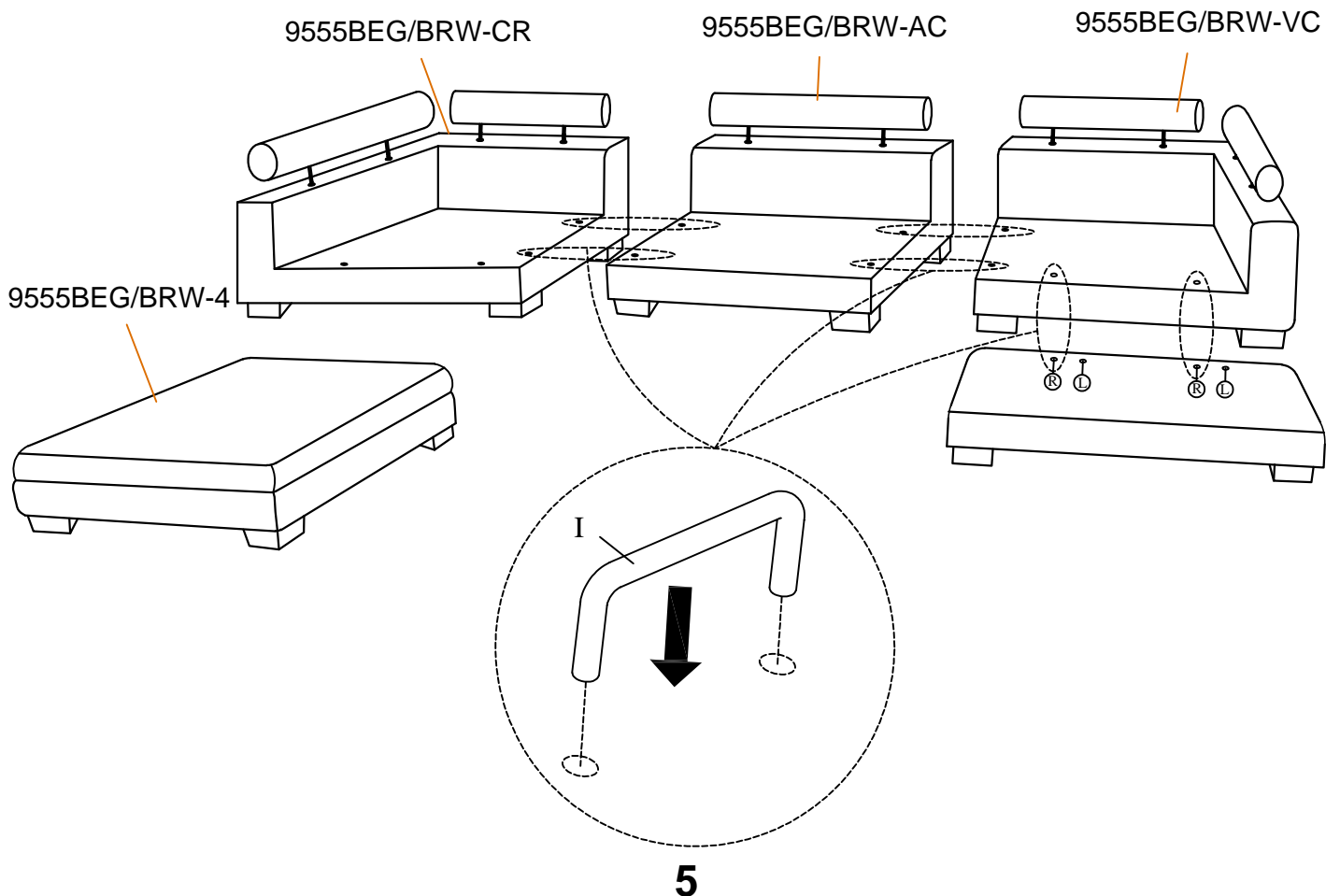

Step #7

Assembly completed.

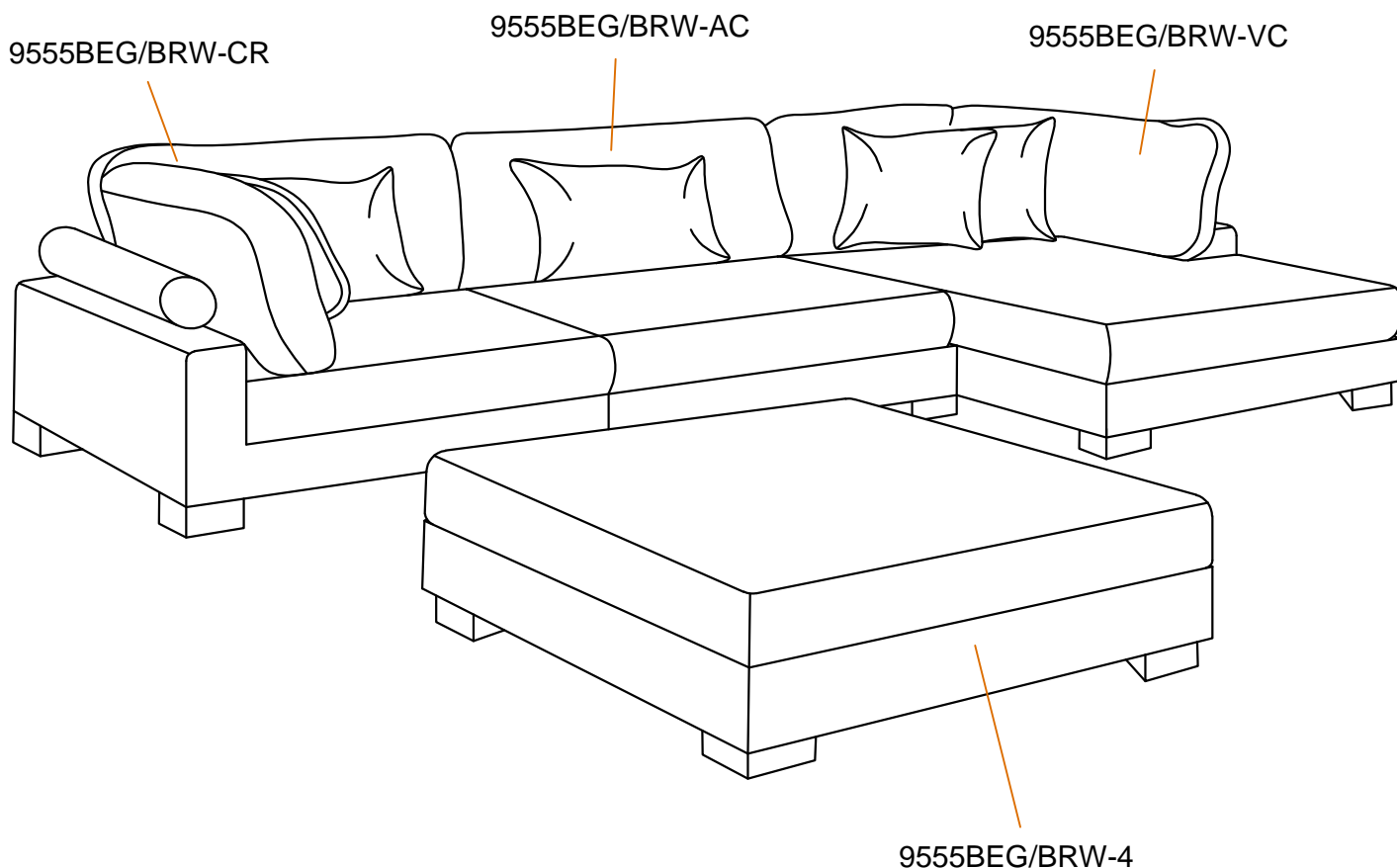

Care Instruction for Textured microfiber Furniture:

In order to maintain the original appearance of your Textured microfiber please follow below simple care procedures:

- Avoid exposing furniture directly to sunlight or heating and air conditioning outlets. Sunlight and/or exposure to heating and air conditioning outlets will fade/damage Textured microfiber. Do not place your upholstered furniture too close to windows, radiators, or vents, and be sure to use windows, radiators, or vents.
- Vacuum or wipe with a soft cloth to remove dust.
- Hardware may loosen over time. Periodically check to make sure all connections are tight. Re-tighten if necessary.



For items use on wooden floor, hard surfaces or carpets, it is recommended to Install protective pads under all legs and supports to avoid/prevent from damages/scratches and discoloration.