

ASSEMBLY INSTRUCTION INSTRUCTION D'ASSEMBLAGE

5773DC/WH-32

3PCS PACK COUNTER HEIGHT SET - CHAIR
ENS.3MCX HAUTEUR COMPTOIR - CHAISE

Thank you for purchasing this product. Please take time to read and follow instructions below. Check that you have all parts and hardware before assembly. Parts apparently missing are often found in packing materials. If you do not have all parts listed, call us and they be sent to you immediately .







Merci d'avoir acheté ce produit. Veuillez lire et suivre les instruntions ci-dessous. Vérifiez avant le montage quevous avez toutes les pièces et fixation. Les pièces qui semblent manquer se trouvent souvent dans les matériaux d'emblage. Si vous n'avez pas toutes les pièces de la liste, appelez-nous et nous vous les enverrons immédiatement.







! It is recommended to install protective pads under all legs and supports to avoid damage or scratches when placing furniture on a wood floor or other hard surface, and to limit indentation and prevent discoloration if placing on carpet.

! Il est recommandé de placer des coussins protecteurs sous tous les pieds et toutes les bases des meubles pour éviter d'endommager ou d'égratigner les planchers en bois ou autres surfaces dures, et pour limiter l'empreinte et empêcher la décoloration quand les meubles reposent sur la moquette .

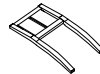
DO NOT TIGHTEN BOLTS UNTIL COMPLETELY ASSEMBLED.

NE PAS SERRER LES BOULONS JUSQU'À CE QUE LE MONTAGE SOIT COMPLETMENT TERMINE

HARDWARE LIST/ LISTE DE QUINCAILLERIE			
NO.	DESCRIPTION	DRAWING/DESSIN	QTY/QTÉ
1	BOLT / BOULON Ø1/4" x 1-1/2"		2PCS
2	BOLT / BOULON Ø1/4" x 2-3/8"		4PCS
3	BOLT / BOULON Ø1/4" x 3-1/4"		4PCS
4	LOCK WASHER / RONDELLE D'ARET Ø1/4"		10PCS
5	FLAT WASHER / RONDELLE PLATE Ø1/4" x 1/16"		10PCS
6	WOOD SCREW / VIS À BOIS M4*1-1/2"		6PCS
7	ALLEN KEY / CLE ALLEN 1/6" x 2-1/4"		1PC

PARTS LIST/LISTE DE PIÉCES			
A		CHAIR BACK / DOSSIER DE CHAISE	1PC
B		SEAT FRAME WITH CUSHION / CADRE DE SIÈGE AVEC SIÈGE COUSSINE	1PC
C		LEFT LEG / PIED	1PC
D		RIGHT LEG / PIED	1PC
E		FRONT STRETCHER / CIVIÈRE AVANT	1PC
F		LEFT STRETCHER/ CIVIÈRE GAUCHE	1PC
G		RIGHT STRETCHER / CIVIÈRE DROITE	1PC

Step 1/ Étape 1

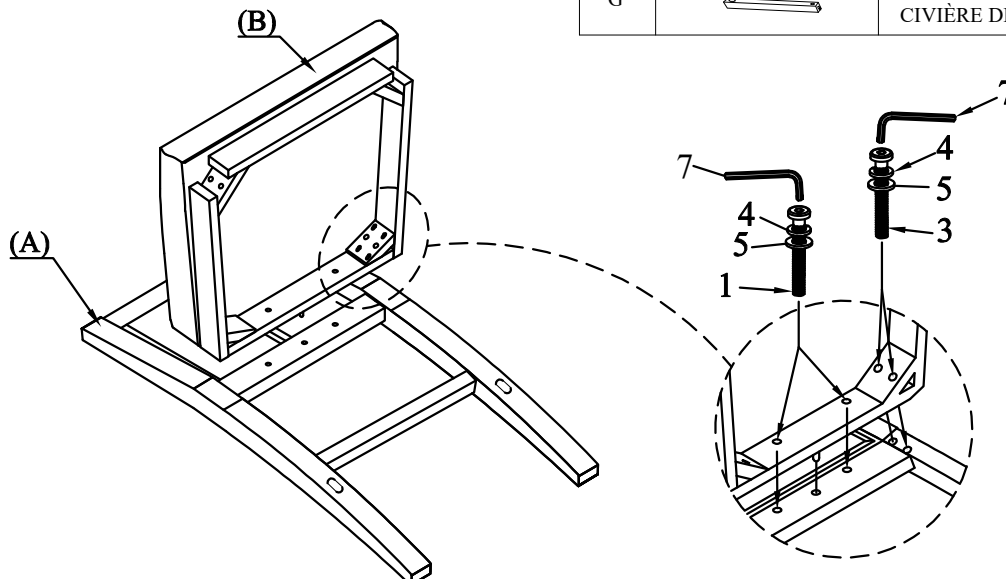



HOMELEGANCE

ASSEMBLY INSTRUCTION INSTRUCTION D'ASSEMBLAGE

5773DC/WH-32

3PCS PACK COUNTER HEIGHT SET - CHAIR
ENS.3MCX HAUTEUR COMPTOIR - CHAISE

Step 2/ Étape 2

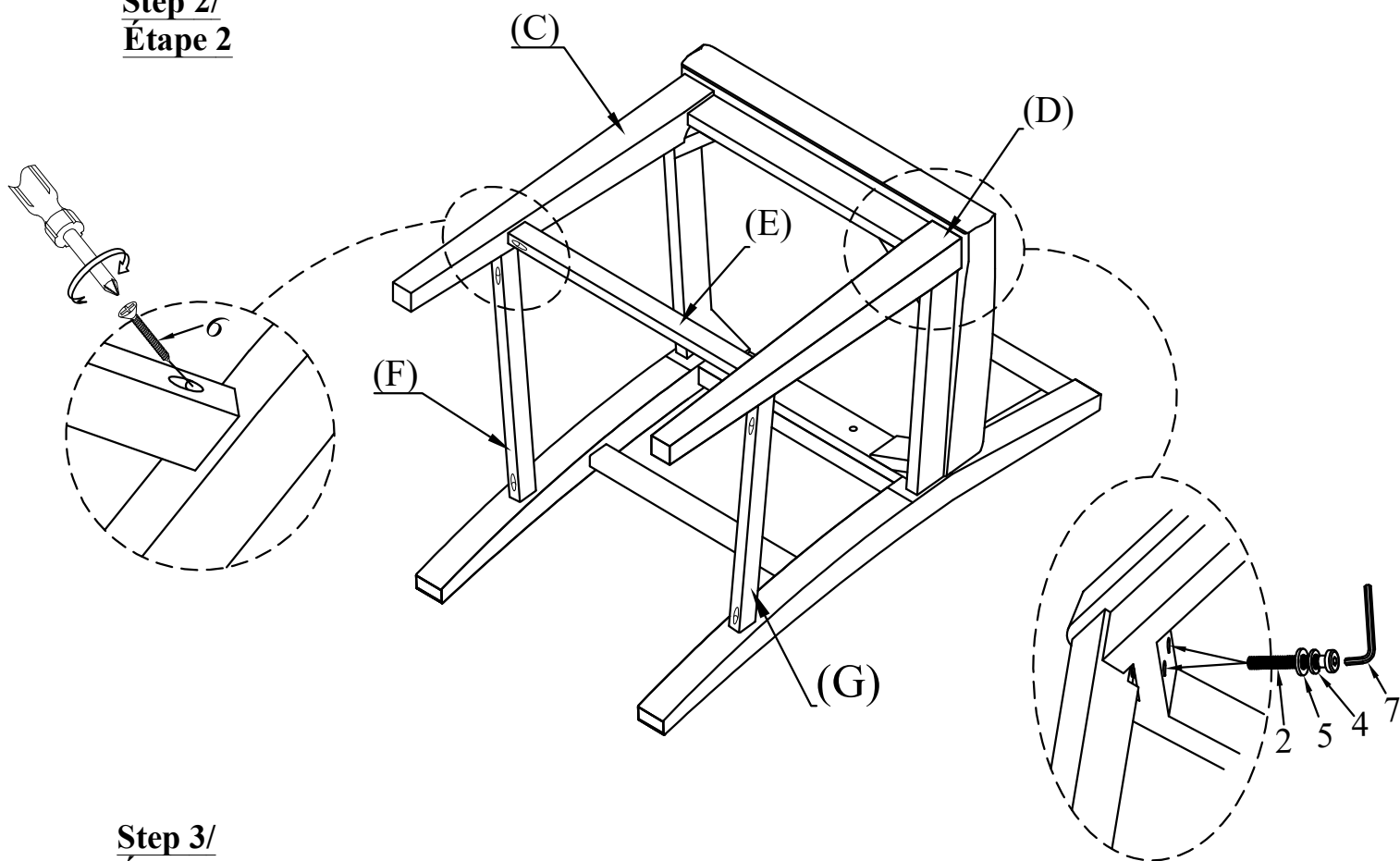

Step 3/ Étape 3

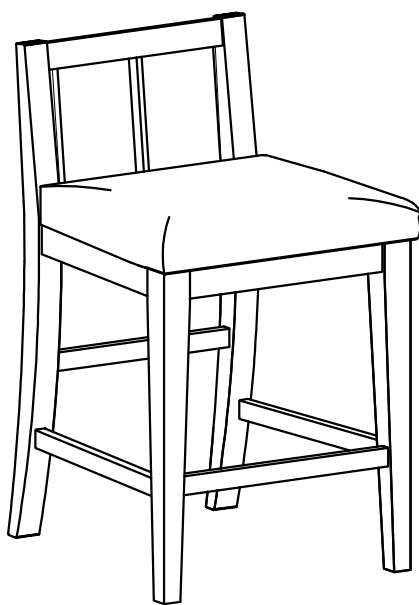

COMPLETED / TERMINÉ