

ASSEMBLY INSTRUCTION

2546-55 BUFFET

PART LIST:

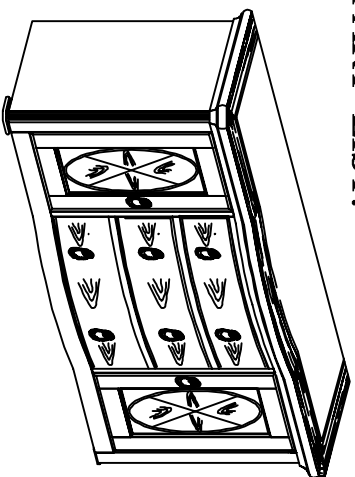

Buffet
1pc

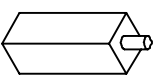





Middle Support Leg
1pc

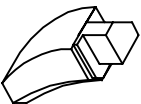
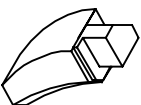

Bun Feet
4pcs



| HARDWARE LIST | | | |
|---------------|--|---------------|-------|
| A |  | L-ALLEN KEY | 1 PC |
| B |  | Bolt | 4 PCS |
| C |  | Spring Washer | 4 PCS |
| D |  | Flat Washer | 4 PCS |

STEP 1

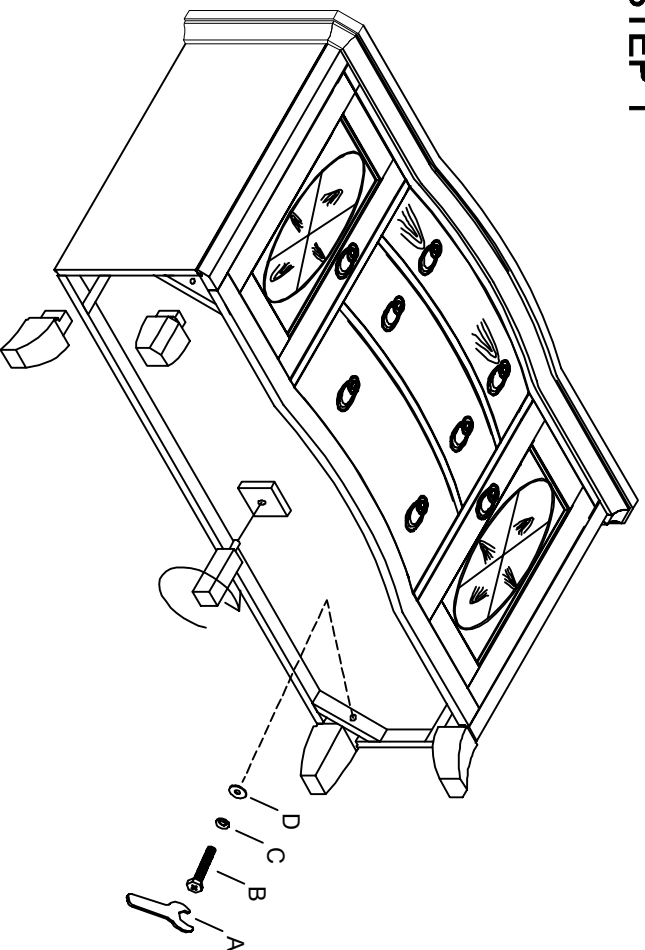

COMPLETED

