



# ASSEMBLY INSTRUCTION

ITEM NO.: 9690BRW/CHC/DGY-1  
**CHAIR**

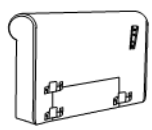
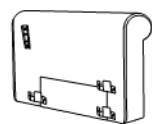

**Legs and hardware are stored in box,  
 please take out for assembly.**

**NOTE: Do not use power tools for assembly. Power tools increase the risk of over tightening which lead to splitting or cracking the wood.**

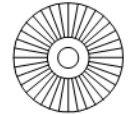
NO.	DRAWING	QTY	DESCRIPTION
A		1	Seat
B		1	LSF Armrest
C		1	RSF Armrest
D		1	Back Rest
E		4	Plastic Leg
F		4	Plastic Washer

# Exploded View

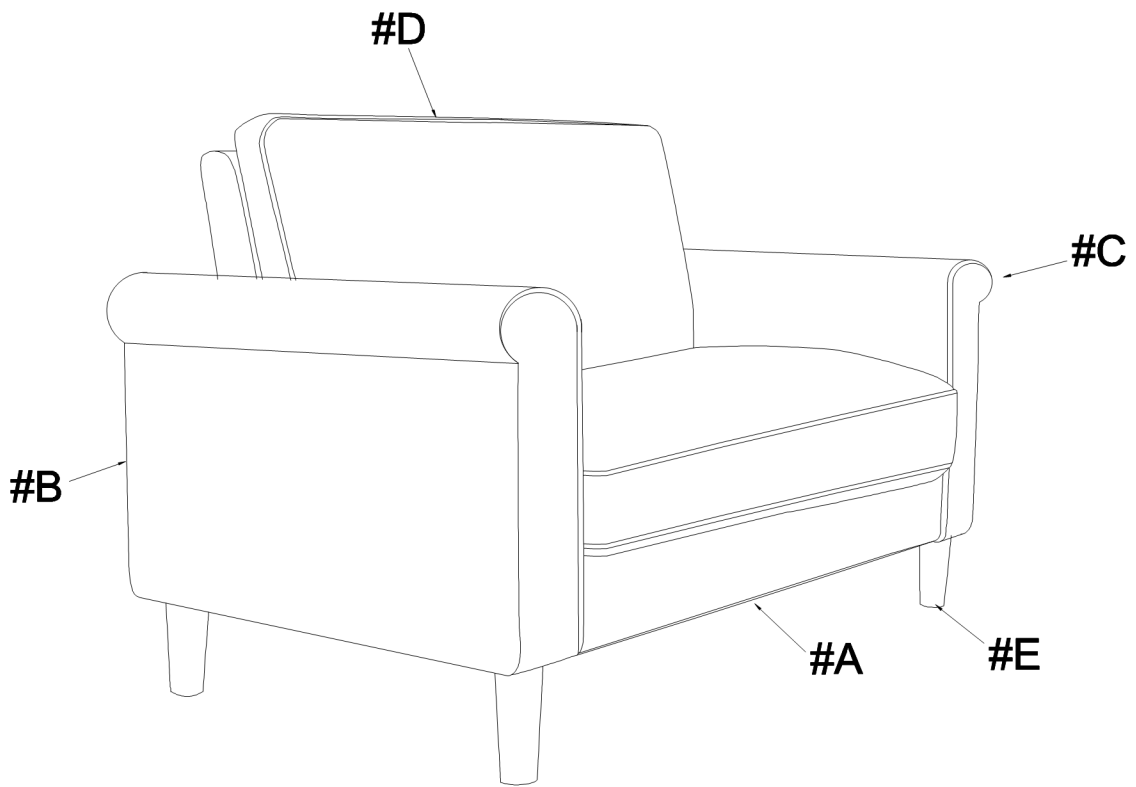

# STEP 1:

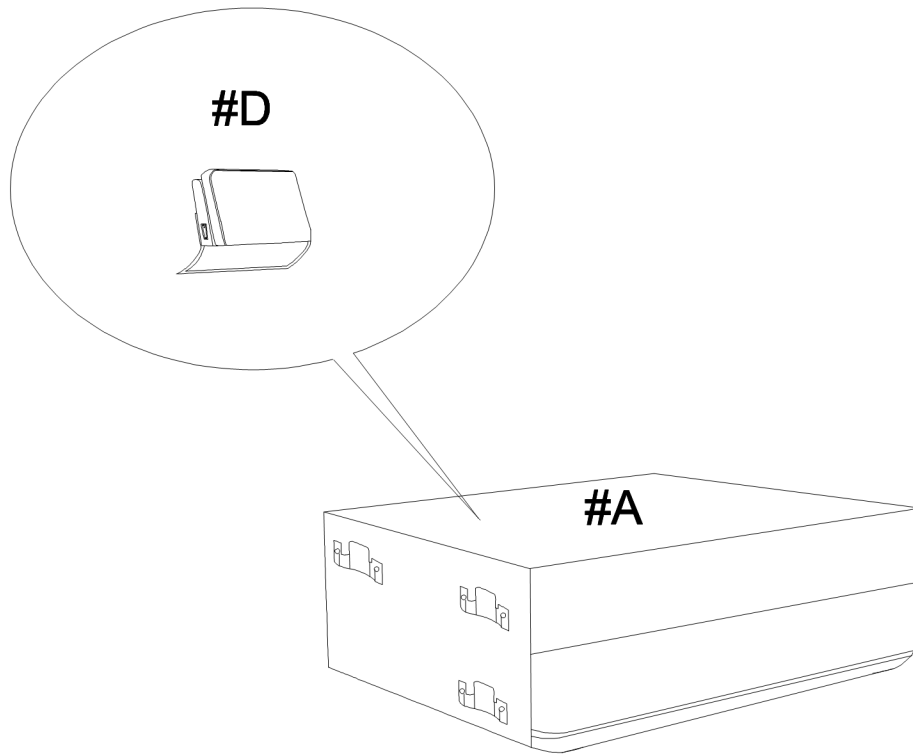

# STEP 2:

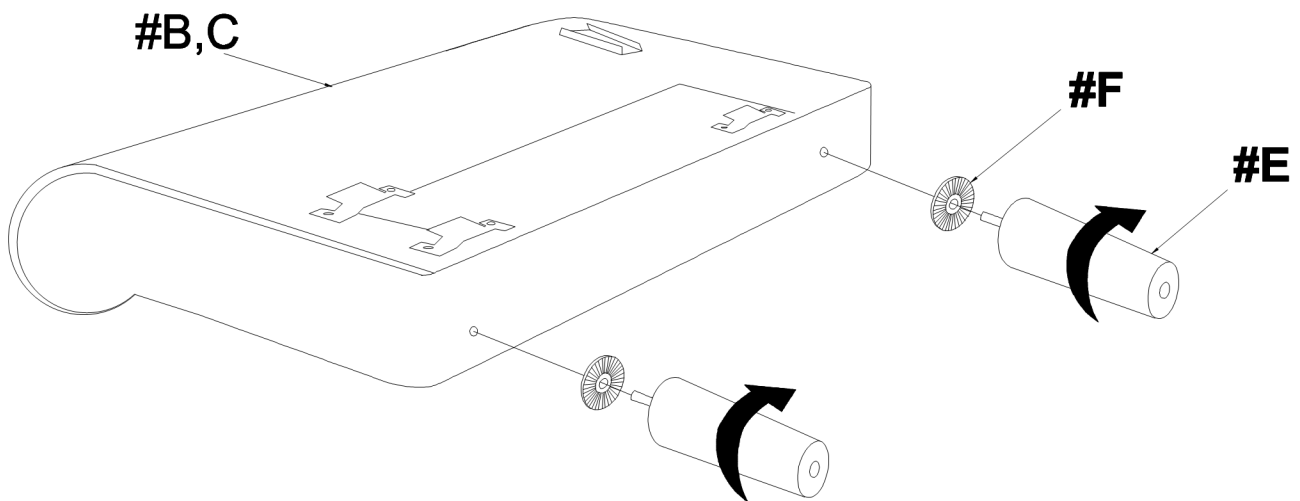

### STEP 3:

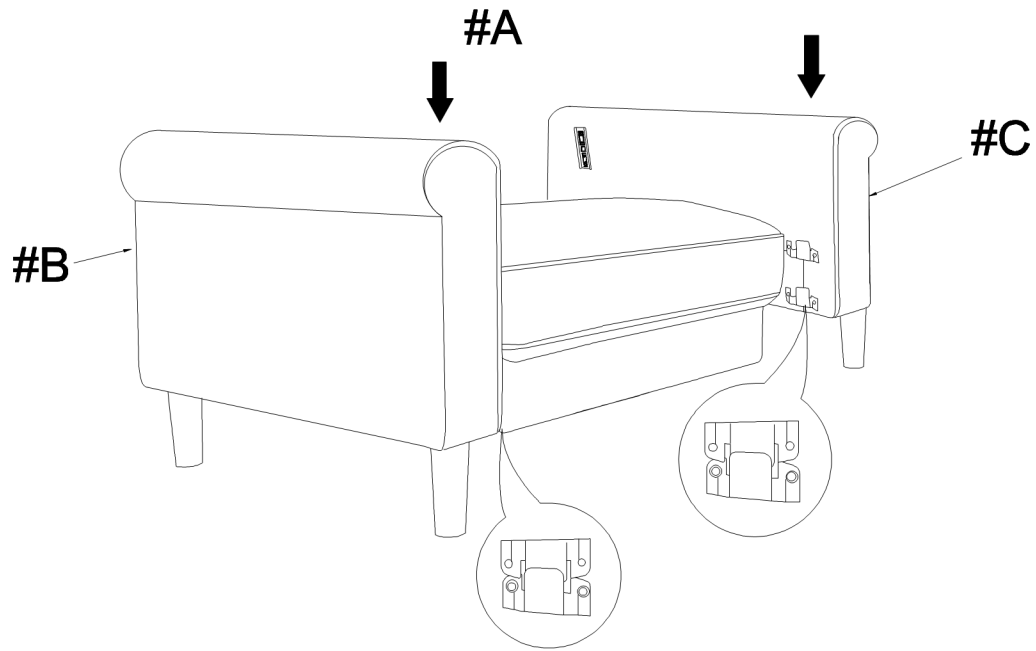

### STEP 4:

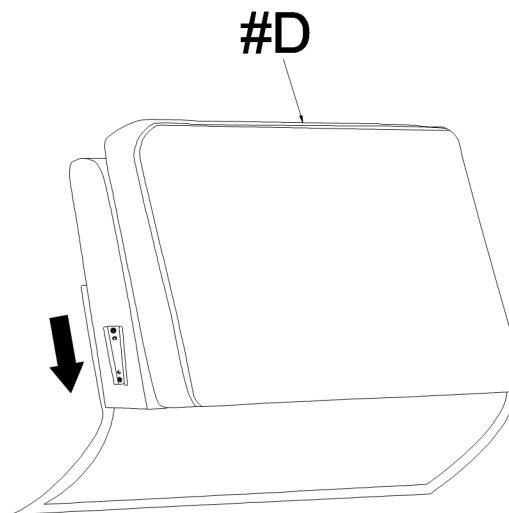

**STEP 5:**

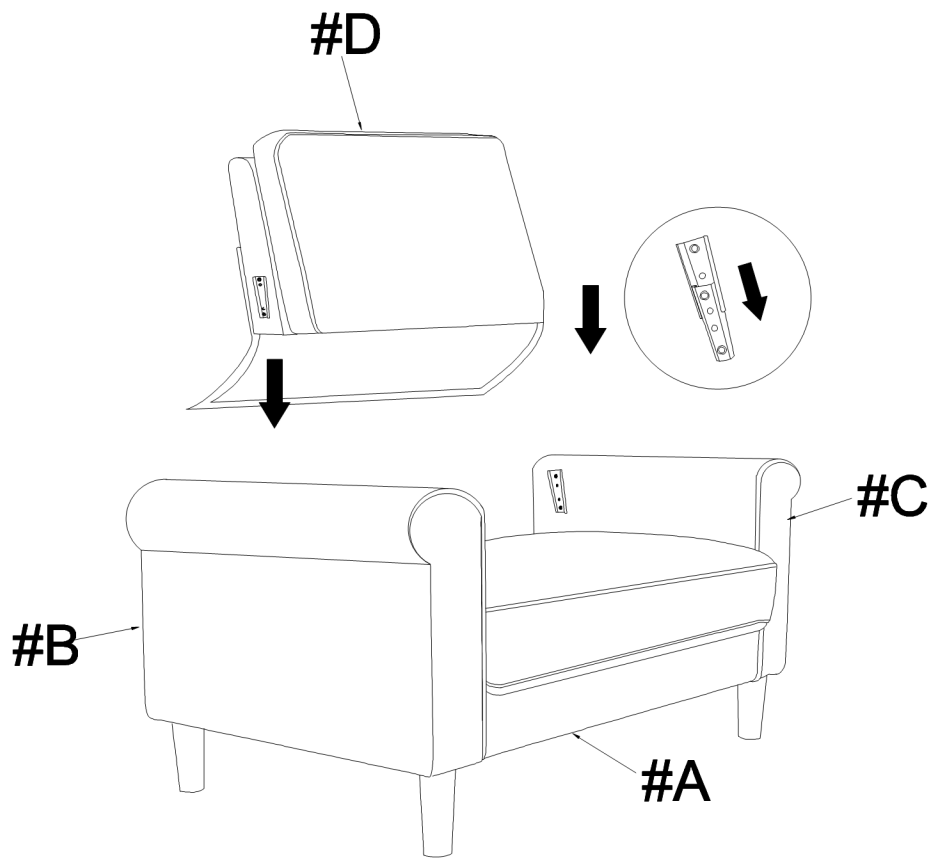

**STEP 6:**

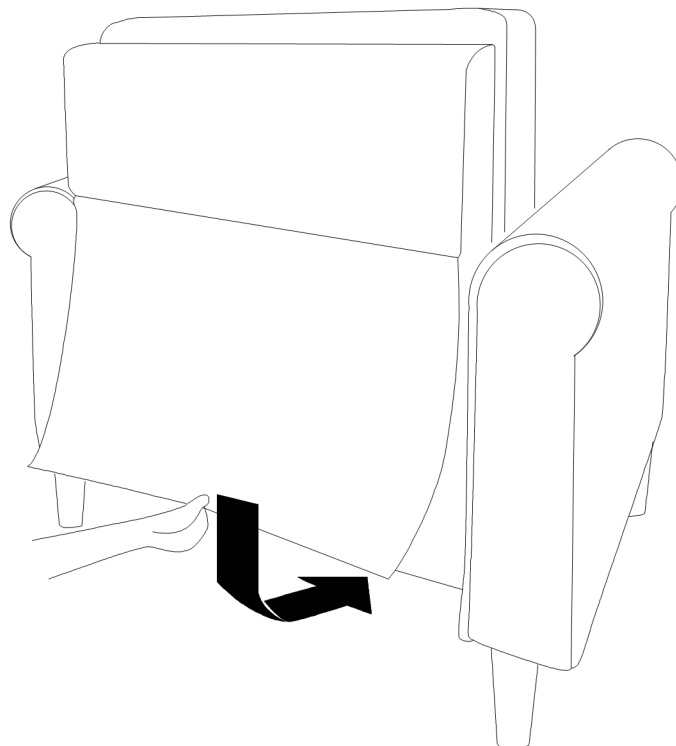

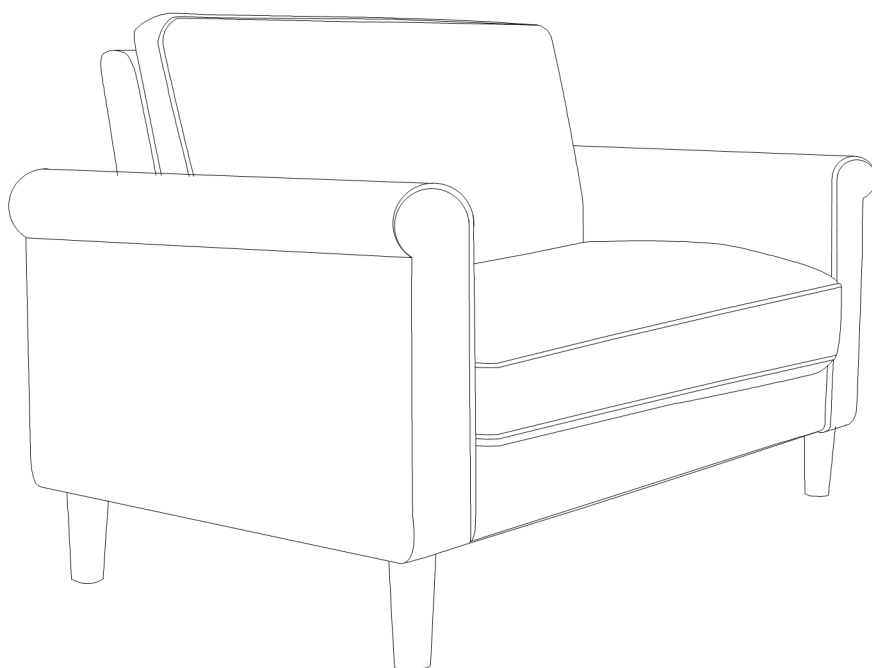

### **Care instruction on for PU furniture:**

In order to maintain the original appearance of your PU furniture, please follow below simple care procedures:

- Avoid exposing furniture directly to sunlight or heating or heating conditioning outlets. Sunlight and or exposure to heating and air conditioning outlets will fade/damage PU.
- Do not place your upholstered furniture too close to windows, radiators, or vents, and be sure to use windows, radiators, or vents.
- Vacuum or wipe with a cloth regularly to remove dust.



For items used on wooden floor, hard surfaces or carpets, it is recommended to install protective pads under all legs and supports to avoid/prevent from damages/scratches and discoloration.