







HOME ELEGANCE

ASSEMBLY INSTRUCTION

ITEM NO: 5939-84 (1/2) DINING TABLE TOP

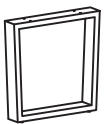
5939-84B (2/2) DINING TABLE METAL BASE

NO	PARTS LIST		QTY	NO	HARDWARE LIST (PACKED IN 5939-84B)		QTY
A		TABLE TOP	1	C		ALLEN BOLT 1/4x60mm	8
				D		SPRING WASHER 1/4 x 10mm x 2mm	8
B		TABLE BASE	2	E		FLAT WASHER 1/4 x 16mm x 2mm	8
				F		ALLEN KEY	1

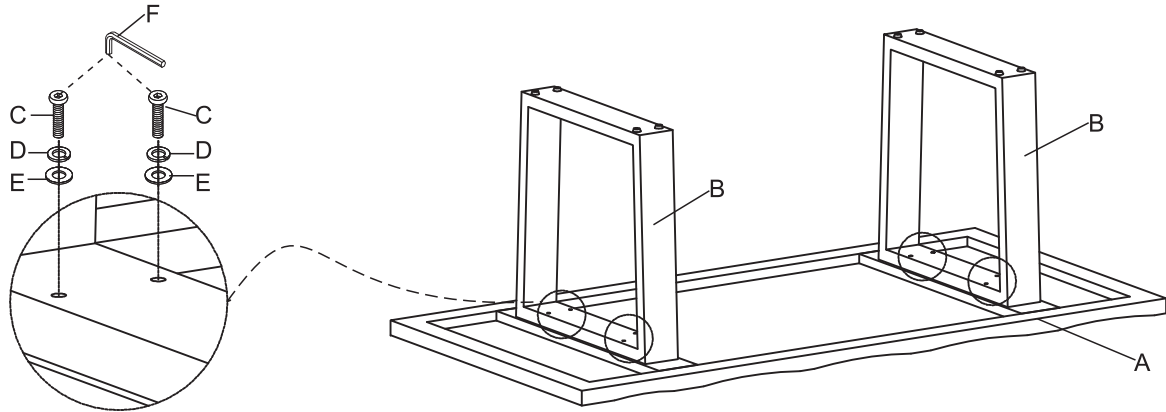

STEP 1

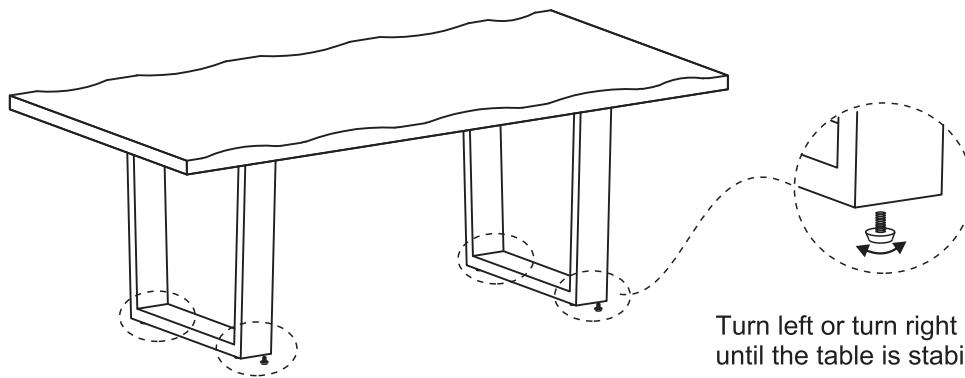

Turn left or turn right to adjust the leveler until the table is stabilized

COMPLETED

▲ It is recommended to install protective pads under all legs and supports to avoid damage or scratches when placing furniture on a wood floor or other hard surface, and to limit indentation and prevent discoloration if placing on carpet.
DO NOT TIGHTEN BOLTS UNTIL COMPLETELY ASSEMBLED.
HARDWARE MAY LOOSEN OVER TIME. PERIODICALLY CHECK TO MAKE SURE ALL CONNECTIONS ARE TIGHT.
RE-TIGHTEN IF NECESSARY.