









Thank you for purchasing this product. Please take time to read and follow the instructions below. Check that you have all parts and hardware before assembly. Parts apparently missing are often found in the packing materials. If you do not have all the parts listed, have your dealer contact us and they will be sent to you immediately.

**It is recommended to install protective pads under all legs and supports to avoid damage or scratches when placing furniture on a wood floor or other hard surface, and to limit indentation and prevent discoloration if placing on carpet.**

Merci d'avoir acheté ce produit de qualité. Vérifiez avant le montage que vous avez toutes les pièces qui semblent manquer se trouvent souvent dans les matériaux d'emballage. Si vous n'avez pas toutes les pièces de la liste, demandez à votre détaillant et nous vous les enverrons immédiatement.

**Il est recommandé de placer des coussins protecteurs sous tous les pieds et toutes les bases des meubles pour éviter d'endommager ou d'égratigner les planchers en bois ou autres surfaces dures, et pour limiter l'empreinte et empêcher la décoloration quand les meubles reposent sur la moquette.**

PARTS LIST / LISTE DES PIÈCES			
ITEM / OBJET	DESCRIPTION / LA DESCRIPTION	SKETCH / ESQUISSE	QTY / QTÉ
A	DRESSER / UNE COMMODE		1 PC
B	LEG(i) / JAMBE(i)		2 PCS
C	LEG(ii) / JAMBE(ii)		2 PCS
D	CENTRE SUPPORT LEG / JAMBE DE SOUTIEN DU CENTRE		1 PC

HARDWARES LIST / LISTE DES MATÉRIELS			
ITEM / OBJET	DESCRIPTION / LA DESCRIPTION	SKETCH / ESQUISSE	QTY / QTÉ
1	JCBC SCREW / BOULON JCBC (M6 x 40MM)		4 PCS
2	SPRING WASHER / RONDELLE ÉLASTIQUE (M6 x 13MM)		4 PCS
3	FLAT WASHER / RONDELLE PLATE (M6 x 19MM)		4 PCS
4	WOOD DOWEL / GOUJON EN BOIS (M8 x 30MM)		4 PCS
5	ALLEN KEY / CLÉ ALLEN (M4 x 65MM)		1 PC
6	TIPPING RESTRAINT / CONTRAINTE DE BASCULEMENT (Packed in 1525-5 for assembly / Emballé en 1525-5 pour l'assemblage)		1 SET

### STEP 1 / ÉTAPE 1

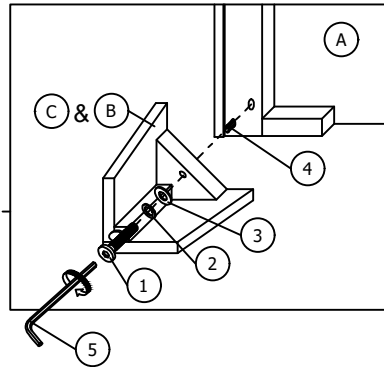
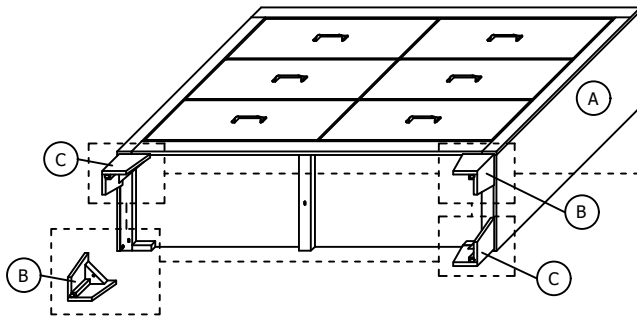

### STEP 2 / ÉTAPE 2

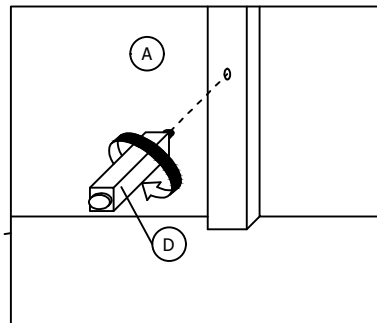
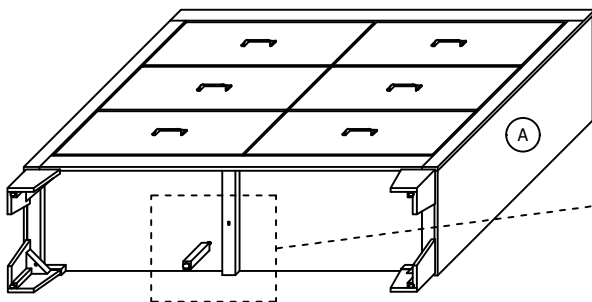



HOME ELEGANCE

# ASSEMBLY INSTRUCTION / INSTRUCTION D' ASSEMBLAGE

## 1525-5 DRESSER

### STEP 3 / ÉTAPE 3

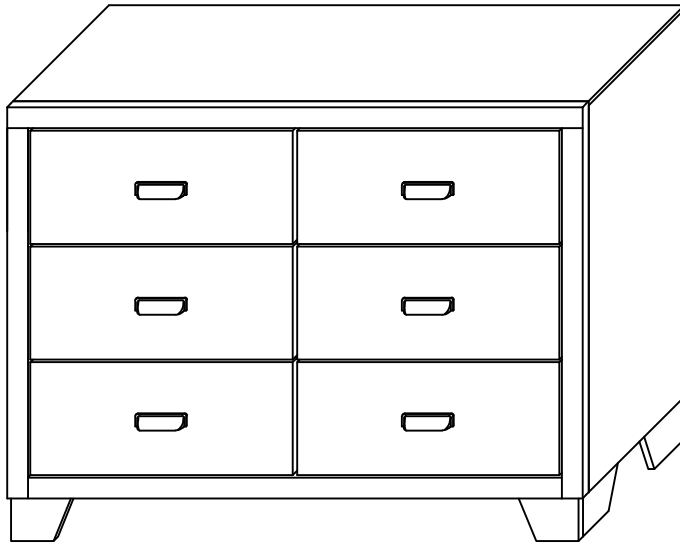

**ASSEMBLY COMPLETED / ASSEMBLÉ**

### STEP 4 / ÉTAPE 4

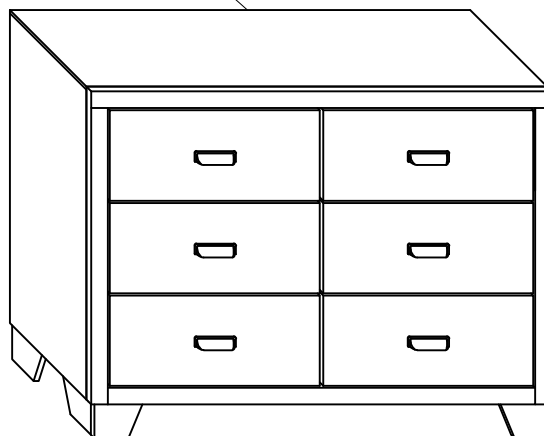
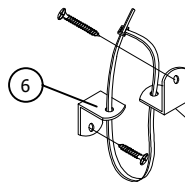

**COMPLETED / TERMINÉ**



#### NOTE / REMARQUE

Tipping Restraint hardware kit is included with this product. Refer to installation instruction in the hardware pack.  
Le kit de matériel de retenue de basculement est inclus avec ce produit. Reportez-vous aux instructions d'installation dans le pack de matériel.

\*ANTI-TIPPING HARDWARE PACK IS AT THE BACK PANEL.

\*LE PACK MATÉRIEL ANTI-BASCULEMENT EST SUR LE PANNEAU ARRIÈRE.

MADE IN MALAYSIA / FABRIQUÉ EN MALAISIE

PAGE 2 OF 2 / PAGE 2 SUR 2