



ITEM: 1313NK-1 King Uph Headboard
1313NK-2 King Storage Footboard & Slats
1313N-3 Queen/ King Side Rail

Thank you for purchasing this quality product. Be sure to check all packing material carefully for small parts which may have come loose inside the carton during shipment. Identify and count all parts and compare with the Parts List below.

! For items use on wooden floor, hard surfaces or carpets, it is recommended to Install protective pads under all legs and supports to avoid/ prevent from damages/ scratches and discoloration.







! Pour les articles Utilisés sur un plancher en bois, des surfaces dures ou tapis, il est recommandé d'installer des mordaches de protection sous tous les jambes et prend en charge pour éviter/empecher de dommages/rayures et la décoloration.

HARDWARE LIST OF FOOTBOARD
HARDWARE PACK IS IN-1313NK-2

NO	DRAWING	DRESCRIPTION	Q'TY
1		#8*1" Screw	22Pcs

COMPONENT LIST		
A	HEADBOARD	1PC
B	FOOTBOARD DRAWER	1PC
C	SIDE RAIL	2PCS
D	SLAT (11PCS)	1SET
E	SLAT SUPPORT LEG SHORT(32*32*314mm)	10PCS

HARDWARE LIST OF BED RAIL
HARDWARE PACK IS IN-1313N-3

NO	DRAWING	DRESCRIPTION	Q'TY
2		Ø5/16"-18*3-1/2" Hanger Bolt	8Pcs
3		Ø50 Arc Washer	8Pcs
4		Ø5/16"*16*2mm Flat Washer	8Pcs
5		Ø5/16" Lock Washer	8Pcs
6		Ø5/16"*L17 Nut	8Pcs
7		Ø5/16" Open Wrench	1Pc



**ITEM: 1313NK-1 King Uph Headboard
1313NK-2 King Storage Footboard & Slats
1313N-3 Queen/ King Side Rail**

Thank you for purchasing this quality product. Be sure to check all packing material carefully for small parts which may have come loose inside the carton during shipment. Identify and count all parts and compare with the Parts List below.

! For items use on wooden floor, hard surfaces or carpets, it is recommended to install protective pads under all legs and supports to avoid/ prevent from damages/ scratches and discoloration.

! Pour les articles Utilisés sur un plancher en bois, des surfaces dures ou tapis, il est recommandé d'installer des mordaches de protection sous tous les jambes et prend en charge pour éviter/empêcher de dommages/raies et la décoloration.

! This device complies with Part 15 of the FCC Rules. Operation is subject to the following two conditions: (1) This device may not cause harmful interference. and(2) this device must accept any interference received, including interference that may cause undesired operation.

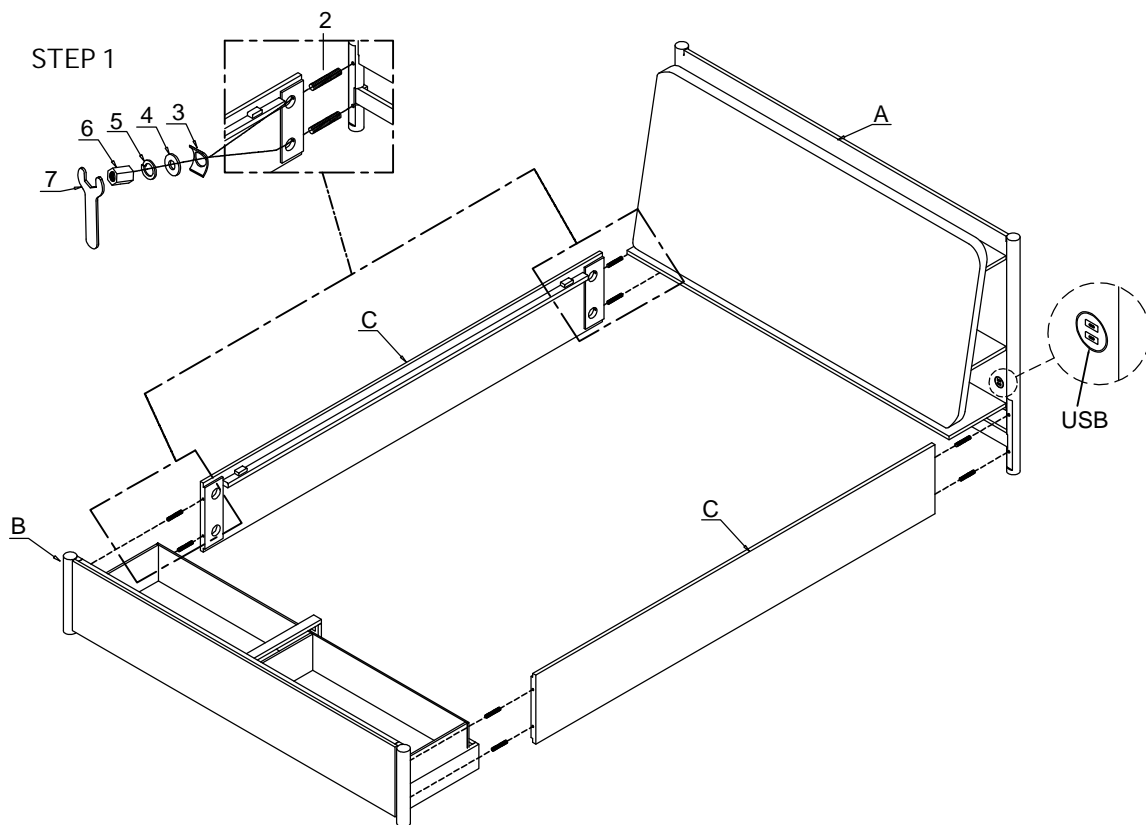

IMPORTANT SAFETY INSTRUCTIONS

"THIS FIXTURE IS EQUIPPED WITH APOLARIZED ATTACHMENT PLUG (A) PLUG HAVING ONE BLADE WIDER THAN THE OTHE). THIS PLUG WILL FIT IN A POLARIZED OUTLET ONLY ONE WAY. THIS IS A SAFETY FEATURE. IF YOU ARE UNABLE TO INSERT THE PLUG FULLY IN THE OUTLET, REVERSE THE PLUG. IF IT STILL WILL NOT FIT, CONTACT A QUALIFIED, ELECTRICIAN. NEVER USE WITH AN EXTENSION CORD UNLESS THE PLUG CAN FULLY INSERTED. DO NOT ATTEMPTTO DEFETAT THE SAFETY PURPOSE OF THE POLARIZED PLUG"

CAUTION:

TO PREVENT ELECTRIC SHOCK DO NOT USE THIS (POLARIZED)PLUG WITH AN EXTENSION CORD, RECEPTACLE OR OTHER OUTLET UNLESS THE BLADES CAN BE FULLY INSERTED TO PREVENT BLADE EXPOSURE.

ATTENTION:

POUR PRÉVENIRLES CHOCS ÉLECTRIQUES NE PAS UTILISER CETTE FICHE POLARISÉE AVEC UN PROLONGATEUR, UNE PRISE DE COURANT OU UNE AUTRE SORTIE DE, COURANT, SAUF SI LES LAMES PELVENT ÊTRE INSÉRÉES À FOND SANS EN LAISSER AUCUNE PARTIE À DÉCOUVERT.



ITEM: 1313NK-1 King Uph Headboard
1313NK-2 King Storage Footboard & Slats
1313N-3 Queen/ King Side Rail

Thank you for purchasing this quality product. Be sure to check all packing material carefully for small parts which may have come loose inside the carton during shipment. Identify and count all parts and compare with the Parts List below.

! For items use on wooden floor, hard surfaces or carpets, it is recommended to install protective pads under all legs and supports to avoid/ prevent from damages/ scratches and discoloration.

! Pour les articles Utilisés sur un plancher en bois, des surfaces dures ou tapis, il est recommandé d'installer des mordaches de protection sous tous les jambes et prend en charge pour éviter/empêcher de dommages/rayures et la décoloration.

